

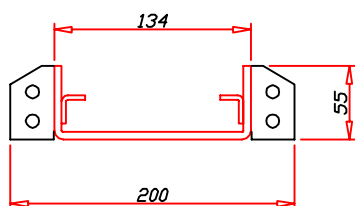

System SWL Schwerlastrinne 50 / 75 / 100

Schwerlastrinne aus Edelstahl V2a 1.4301
mit Verbindungsflaschen, Nivellierfüssen,
Verbindungsschrauben / Elementlänge 2.0 m
Breite 134 / 200 mm



120-050-2	SWL 50	Schwerlastrinne	CHF	435.00 lfm
120-075-2	SWL 75	Schwerlastrinne	CHF	463.00 lfm
120-100-2	SWL 100	Schwerlastrinne	CHF	514.00 lfm

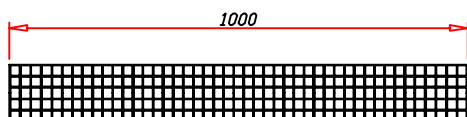

800-040-1	Gitterrost aus Stahl feuerverzinkt Belastungsklasse B MW 20 x 20 Länge 1000 mm	CHF	43.00 Stk.
-----------	---	-----	------------

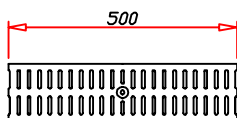

800-090-5	Kunststoffrost Belastungsklasse C Schlitzweite 40 x 6 mm Länge 500 mm	CHF	45.00 Stk.
-----------	---	-----	------------

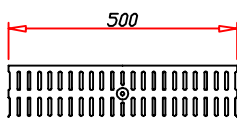

800-070-4	Gussrost GGG KTL-Beschichtung Belastungsklasse E Schlitzweite 40 x 7 mm Länge 500 mm	CHF	44.00 Stk.
-----------	--	-----	------------

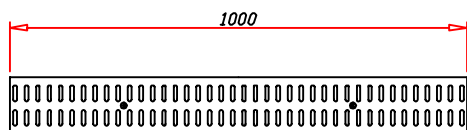

Schlitzrost aus Edelstahl V2a 1.4301
Schlitzweite 35 x 8 mm
Länge 1000 mm

800-050-2	Schlitzrost Klasse A	CHF	63.00 Stk.
800-055-2	Schlitzrost Klasse B	CHF	92.00 Stk.
800-060-2	Schlitzrost Klasse C	CHF	128.00 Stk.
800-065-2	Schlitzrost Klasse D	CHF	246.00 Stk.

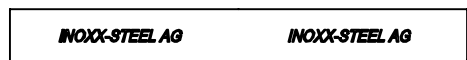

580-000-5	Bretteinlage zum Schutz der Rinne während des betonierens gehobelt / Länge variabel	CHF	15.00 lfm
-----------	---	-----	-----------



System SWL Schwerlastrinne 50 / 75 / 100

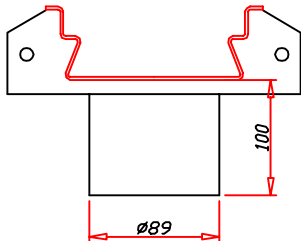

Ablaufstutzen aus Edelstahl V2a 1.4301
senkrecht / Länge 100 mm

510-010-2	DN 76	CHF	57.00 Stk.
510-015-2	DN 89	CHF	66.00 Stk.
510-020-2	DN 108	CHF	73.00 Stk.

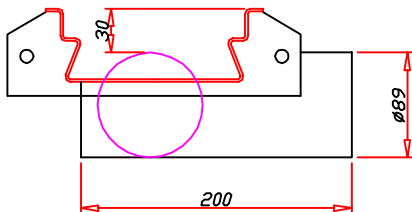

Ablaufstutzen aus Edelstahl V2a 1.4301
waagrecht / Länge 100 mm

510-030-2	DN 76	CHF	103.00 Stk.
510-035-2	DN 89	CHF	106.00 Stk.
510-040-2	DN 108	CHF	132.00 Stk.

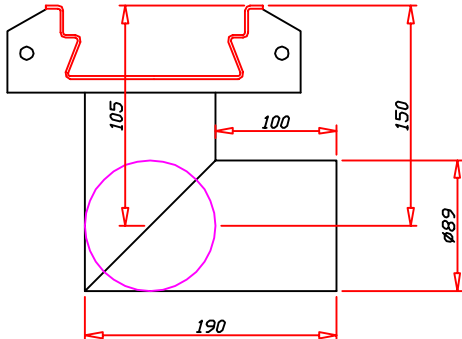

Ablaufstutzen aus Edelstahl V2a 1.4301
stirnseitig / Länge 100 mm

510-045-2	DN 76	CHF	156.00 Stk.
510-050-2	DN 89	CHF	168.00 Stk.
510-055-2	DN 108	CHF	192.00 Stk.

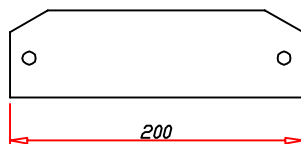

520-022-2	Anfang- und Endstücke verschraubt Edelstahl V2a 1.4301 Rinnenhöhe 30 - 100 mm	CHF	52.00 Stk.
-----------	---	-----	------------



810-005-2	Rostarreterungen Edelstahl V2a 1.4301 zu Entwässerungsrinnen 30 bis 100 mm	CHF	11.50 Stk.
-----------	--	-----	------------

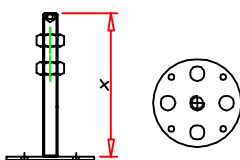

Einbaustützen verzinkt / roh
mit je 2 Muttern

530-020-1	bis 20 cm	CHF	12.00 Stk.
530-030-1	bis 30 cm	CHF	14.00 Stk.
530-050-1	bis 50 cm	CHF	16.00 Stk.



System SWL Schwerlastrinne 50 / 75 / 100

Einlaufkasten mit Geruchsverschluss
Edelstahl V2a 1.4301
DIM: 300 x 110 x 150 mm
inkl. Schmutzfänger

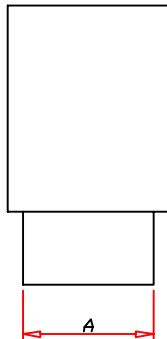
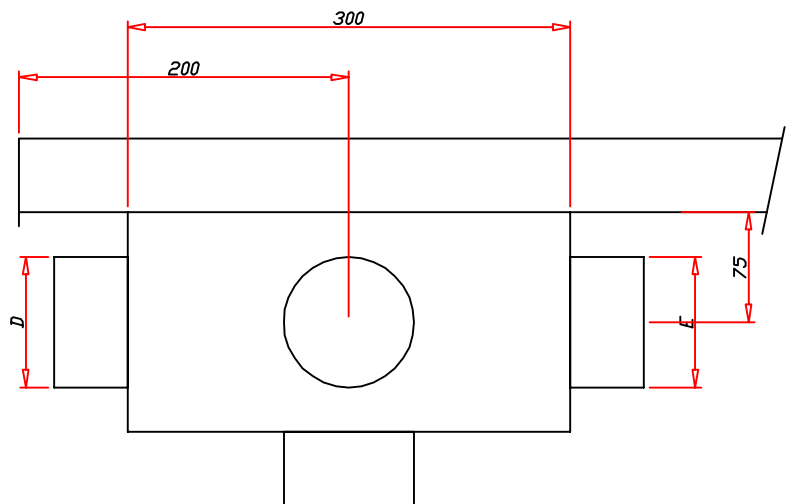
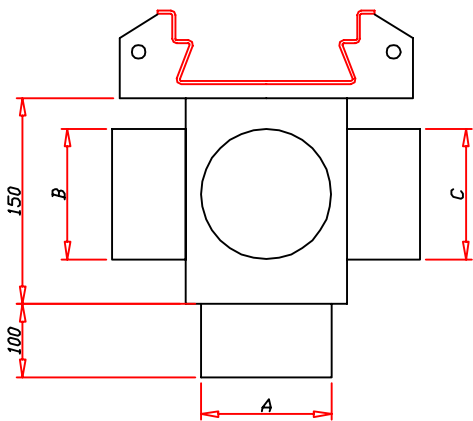

540-010-2	DN 76 senkrecht	CHF	570.00 Stk.
540-015-2	DN 89 senkrecht	CHF	582.00 Stk.
540-020-2	DN 108 senkrecht	CHF	596.00 Stk.

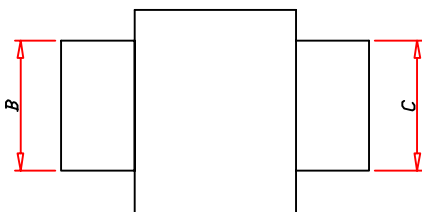

540-025-2	DN 76 waagrecht	CHF	570.00 Stk.
540-030-2	DN 89 waagrecht	CHF	582.00 Stk.
540-035-2	DN 108 waagrecht	CHF	596.00 Stk.

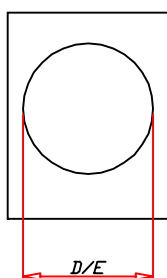

540-040-2	DN 76 stirnseitig	CHF	570.00 Stk.
540-045-2	DN 89 stirnseitig	CHF	582.00 Stk.
540-050-2	DN 108 stirnseitig	CHF	596.00 Stk.