

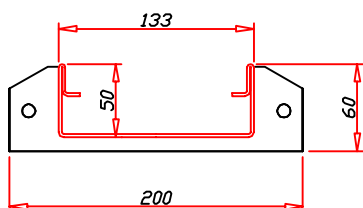

## System AHB Asphalthartbelagsrinne 50 / 75 / 100

**Asphalthartbelagsrinne aus Edelstahl V2a 1.4301**  
mit Verbindungsflaschen, Nivellierfüßen,  
Verbindungsschrauben / Elementlänge 2.5 m  
Breite 133 / 200 mm



110-050-2	<b>AHB 50 Asphalthartbelagsrinne</b>	CHF	142.00 m
110-075-2	<b>AHB 75 Asphalthartbelagsrinne</b>	CHF	164.00 m
110-100-2	<b>AHB 100 Asphalthartbelagsrinne</b>	CHF	187.00 m

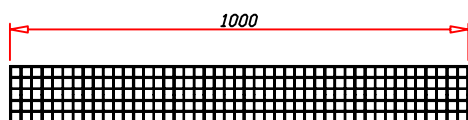

800-040-1	<b>Gitterrost</b> Belastungsklasse B MW 20 x 20 Länge 1000 mm Stahl verzinkt	CHF	43.00 Stk.
-----------	---	-----	------------

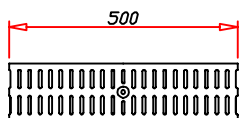

800-090-5	<b>GFK Kunststoffrost</b> Belastungsklasse B Schlitzweite 40 x 6 mm Länge 500 mm	CHF	45.00 Stk.
-----------	---	-----	------------

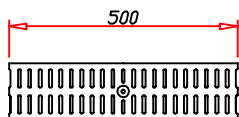

800-070-4	<b>Gussrost GGG</b> Belastungsklasse E Schlitzweite 40 x 7 mm Länge 500 mm	CHF	44.00 Stk.
-----------	---	-----	------------

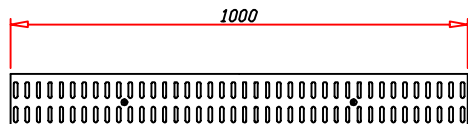

**Schlitzrost aus Edelstahl V2a 1.4301**  
Schlitzweite 35 x 8 mm  
Länge 1000 mm

800-050-2	<b>Schlitzrost Klasse A</b>	CHF	63.00 Stk.
800-055-2	<b>Schlitzrost Klasse B</b>	CHF	92.00 Stk.
800-060-2	<b>Schlitzrost Klasse C</b>	CHF	128.00 Stk.
800-065-2	<b>Schlitzrost Klasse D</b>	CHF	196.00 Stk.

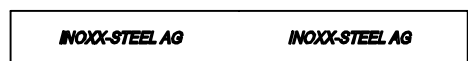

580-000-5	<b>Breiteinlage</b> zum Schutz der Rinne während des betonierens DIM: 124 x 20 mm gehobelt	CHF	15.00 m
-----------	---	-----	---------



**System AHB Asphalthartbelagsrinne 50 / 75 / 100**

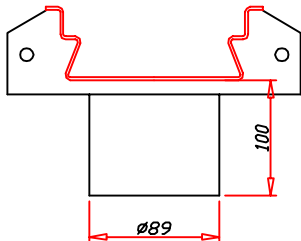

**Ablaufstutzen aus Edelstahl V2a 1.4301**  
senkrecht / Länge 100 mm

510-010-2	DN 76	CHF	57.00 Stk.
510-015-2	DN 89	CHF	66.00 Stk.
510-020-2	DN 108	CHF	73.00 Stk.

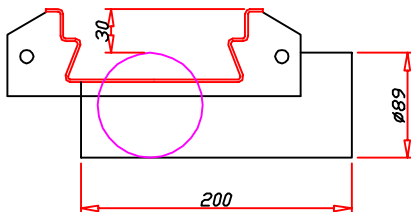

**Ablaufstutzen aus Edelstahl V2a 1.4301**  
waagrecht / Länge 100 mm

510-030-2	DN 76	CHF	103.00 Stk.
510-035-2	DN 89	CHF	106.00 Stk.
510-040-2	DN 108	CHF	132.00 Stk.

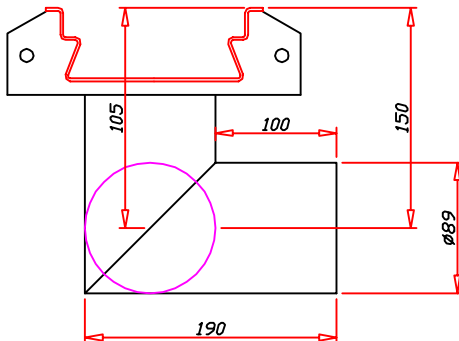

**Ablaufstutzen aus Edelstahl V2a 1.4301**  
stirnseitig / Länge 100 mm

510-045-2	DN 76	CHF	156.00 Stk.
510-050-2	DN 89	CHF	168.00 Stk.
510-055-2	DN 108	CHF	192.00 Stk.

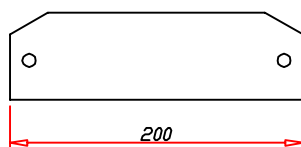

520-022-2	<b>Anfang- und Endstücke</b> verschraubt Edelstahl V2a 1.4301 Rinnenhöhe 30 - 100 mm	CHF	52.00 Stk.
-----------	---	-----	------------



810-005-2	<b>Rostarretierungen</b> Edelstahl V2a 1.4301 zu Entwässerungsrinnen 30 bis 100 mm	CHF	11.50 Stk.
-----------	---	-----	------------

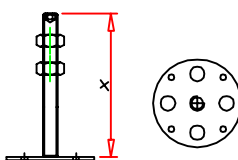

**Einbaustützen verzinkt / roh**  
mit je 2 Muttern

530-020-1	bis 20 cm	CHF	12.00 Stk.
530-030-1	bis 30 cm	CHF	14.00 Stk.
530-050-1	bis 50 cm	CHF	16.00 Stk.



**System AHB Asphalthartbelagsrinne 50 / 75 / 100**

**Einlaufkasten mit Geruchsverschluss**  
Edelstahl V2a 1.4301  
DIM: 300 x 110 x 150 mm  
inkl. Schmutzfänger

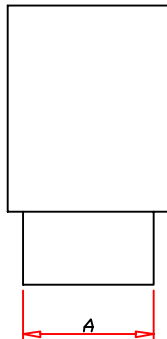
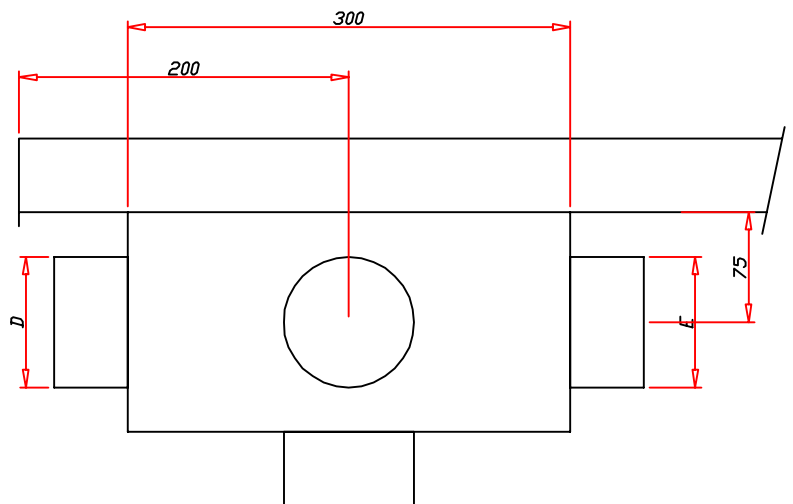
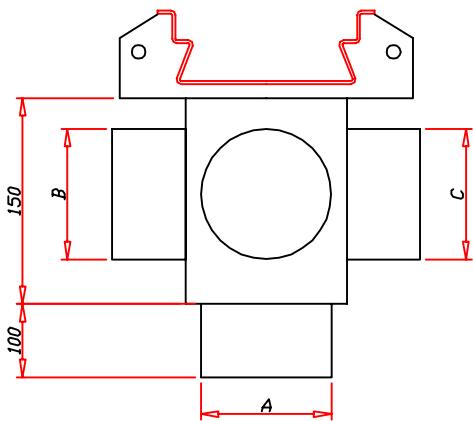

540-010-2	DN 76 senkrecht	CHF	570.00 Stk.
540-015-2	DN 89 senkrecht	CHF	582.00 Stk.
540-020-2	DN 108 senkrecht	CHF	596.00 Stk.

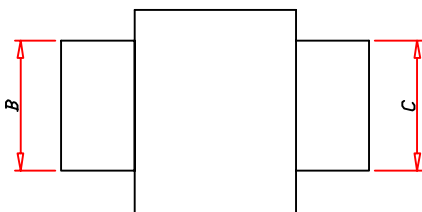

540-025-2	DN 76 waagrecht	CHF	570.00 Stk.
540-030-2	DN 89 waagrecht	CHF	582.00 Stk.
540-035-2	DN 108 waagrecht	CHF	596.00 Stk.

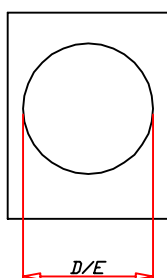

540-040-2	DN 76 stirnseitig	CHF	570.00 Stk.
540-045-2	DN 89 stirnseitig	CHF	582.00 Stk.
540-050-2	DN 108 stirnseitig	CHF	596.00 Stk.